

PLASTER FLOATS



Molded Rubber Floats

- Very dense texture
- Molded black sponge rubber
- Features a comfortable wood handle

No.	Size	
PL395	8"x4"x5/8"	Add "P" to part number for Plastic Handle
PL398	10"x4"x5/8"	



Add "F" to part number for **FINE** Geen Texture Float or Replacement Pads

Green Texture Floats

- Brings aggregate out on any sand surface
- Special coarse green plastic foam
- Features a comfortable wood handle

No.	Size
PL602	10"x4"x3/4"
PL601	12"x4"x3/4"
PL607	12"x5"x3/4"
PL603	12"x5"x1"

Green Replacement Pads

PL702	10"x4"x3/4"
PL703	12"x4"x3/4"
PL707	12"x5"x3/4"
PL701	12"x5"x1"



"Sandsucker" Float

- Perfect for exterior sand finishing
- Pulls the sand right out of the mud
- Pad is made of thick textured red sponge rubber mounted on a metal reinforced flexible rubber back
- Features a comfortable wood handle

No.	Size	
PL350	10"x4"x3/4"	Add "P" to part number for Plastic Handle



Coarse Cell Rubber Floats

- For rough texture surfaces
- Rubber float pad is securely cemented to flat aluminum back
- Features a comfortable wood handle

No.	Size	
PL374	8"x4"x5/8"	Add "P" to part number for Plastic Handle
PL382	10"x4"x3/4"	



Red Rubber Floats

- Sponge rubber securely cemented to flat aluminum back
- Features a comfortable wood handle

No.	Size	
PL373 Fine	8"x5"x1"	Add "P" to part number for Plastic Handle
PL383 Coarse	8"x5"x1"	



Lightweight Rubber Float

- Sponge rubber of correct density, lightweight red float that covers more surfaces

- Features a comfortable wood handle

No.	Size	
PL384	12"x4"x1/2"	Add "P" to part number for Plastic Handle



Jumbo Red Rubber Float

- Popular on the West Coast and Arizona
- Sponge density is the most popular used
- Features a comfortable wood handle

No.	Size	
PL310	12"x5"x3/4"	Add "P" to part number for Plastic Handle



Fine Cell Rubber Floats

- For a fine textured finish
- Rubber pad securely cemented to flat aluminum back
- Features a comfortable wood handle

No.	Size	
PL371	8"x4"x5/8"	Add "P" to part number for Plastic Handle
PL372	10"x4"x3/4"	



Super Poly-Foam Floats

- White poly-foam that looks and wears like rubber
- Does not disintegrate like most foams
- Features a comfortable wood handle

No.	Size	
PL606	10"x4"x3/4"	Add "P" to part number for Plastic Handle
PL605	12"x4"x3/4"	
PL604	12"x5"x1"	

Poly-Foam Replacement Pads

PL706	10"x4"x3/4"
PL705	12"x4"x3/4"
PL704	12"x5"x1"



Angle Float

This lightweight float is perfect for applying material such as brown coat. Square side edges and tapered angles on both ends easily finish to corners. Each side wall is 3/4" high.

No.	Size	Material
PL061	9"x4"	Magnesium



Wood



Plastic

Replacement Float Handles

Your choice of wood or plastic handle.

No.	Description
CF263	7-1/4" Wood Float Handle
CF263P	7-1/4" Plastic Float Handle

Float Pads

Replacement pads available for all floats.

Contact Cement

PL379 Replacement Pad Adhesive (1 pint)

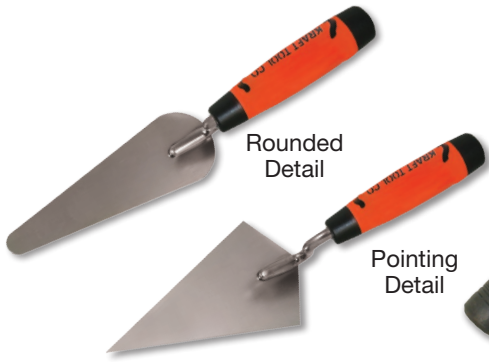

Rounded Detail

Pointing Detail

Rounded Detail and Pointing Detail Trowels

100% Stainless Steel Blade

Great for detailing plaster and EIFS projects.

No.	Size	Description
PL585PF	6"	Rounded Detail
PL586PF	6"	Pointing Detail



Magnetic Nail Hammer

The 6" long head grips nails tightly. Lets you work in tight places. 12-1/2" Soft grip handle. Weighs 34 oz.

No.	Description
PL258SG	Magnetic Hammer
PL258SG-01	Repl. Magnetic Tip NEW



Magnetic Nail Drivers

Stainless steel nail driver. Grips nails tightly. Lets you reach really tight spots. Has 5/8" hexagonal shank, giving you a good grip.

No.	Description
PL252	5-1/2" long, 3/4" diam. nose
PL256	8" long, 9/16" diam. nose



US Patent #6,973,725 B2

Miter Snips

Accurately cuts angles in seconds up to 1" wide x 1/2" thick (replaceable blade). Cuts plastic, decorative moldings and tile edges/trim. Adjustable miter fence with built in protractor. 7 preset angles from 45°-135°. Safety lock handle with no slip grip. To easily change angle, slide the self-indexing metal guide to desired angle.

No.	Description
LA355*	Miter Snips
LA355-01*	Top Cutting Replacement Blade



Sheet Metal Cutting Shears

A favorite with sheet metal, lath and tile professionals. Cuts sheet metal, tile, asphalt, wire, plastic, shingling, carpets. Forged snips are contoured for easier cutting, less fatigue.

No.	Size
LA292*	12-1/2"



Lightweight Aluminum Snips

Comfortable, lightweight tool cuts up to #22 gauge steel and stainless steel up to #26 gauge. Great for vinyl, aluminum siding, vinyl flooring, and roofing materials.

No.	Size
LA377*	13"



Offset/Bent Pattern Snips

Drop forged. Offset blades keep hands clear of metal. Blades individually hand edged for maximum cutting. Rust resistant blades.

No.	Size
LA291*	14"



LA350 Shown

Wiss® Aviation Style Snips

Perfect for metal lath work. Double action. Plastic color coded grips for safety/comfort.

No.	Size
LA205	Left Cutting (Red)
LA207	Right Cutting (Green)
LA350	Straight and Combination (Yellow)

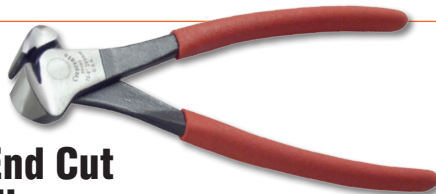

End Cut Nippers

Comfortably cut wire all day long with these steel lather's nippers. Plastic handle grips create a comfortable hold.

No.	Size
LA407*	7"
LA408*	8"



Offset/Bent Pattern Snips

With 6" Long Handles

Keeps hands off lath for protection. Similar to the 14" Snips, this pair features extension handles with rubber grips, allowing for better leverage when cutting metal.

No.	Size
LA293*	19"



Bucket Trowel

Stainless steel tapered blade allows user to eliminate wasted material left in bucket. Comes with wood handle and special tang to hang on side of bucket.

No.	Size
PL800*	7"x4-1/2"x3"



Galvanized Bucket Scoop

Galvanized steel scoop; great for loading trowels and transferring mortar, plaster or stucco material. Comes with wood handle and bucket hanger. Inside of scoop is tapered from 7" to 3-1/2".

No. PL804*



Lid Claw

Remove lids from plastic buckets quickly and easily. Made of strong durable plastic.

No.	Size
DW110	8" Length



Packed 3 per carton

Featheredge

Makes it easy to scrape off mud while following a plastering machine. Perfectly balanced for fingertip control. Width is 4-1/2".

No.	Size
PC004	4'
PC005	5'
PC006	6'
PC007	7'
PC008	8'
PC010**	10'
PC012**	12'

**Must ship via oversized rate or truck

Magnesium Slicker

Ideal for straightening and slicking ceilings. No water needed. Designed with an angle at the top for strength, rigidity and ease of operation. Height 5". Weighs only 18 oz.

No.	Size
PL695	42"

Scratcher Darby "V" Notch

Lightweight magnesium darby with double knob handle. Raised edge for strength. 1/2"x1/2" "V" notch.

No.	Size
PL694	42"

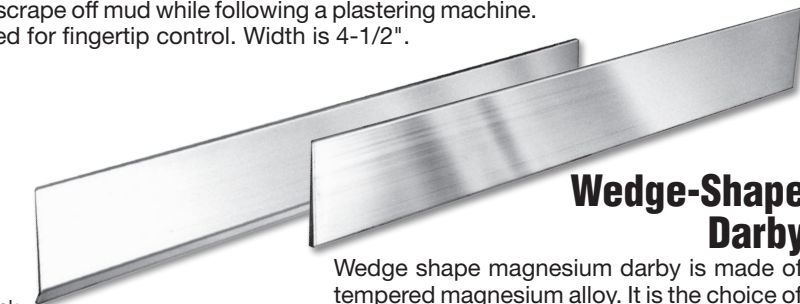

Wedge-Shape Darby

Wedge shape magnesium darby is made of tempered magnesium alloy. It is the choice of the trade. Gives fine smooth finish to plaster. Height is 4-3/4".

No.	Size
PC036	36"
PC042	42"
PC048	48"

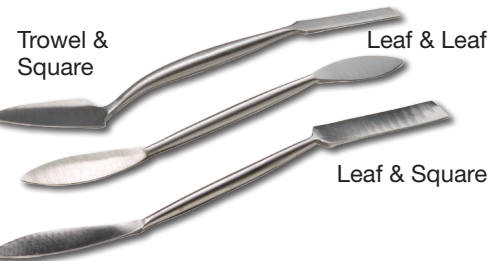

Ornamental Tools

The plasterer's delight! Forged and tempered.

No.	Description	Size	Length
PL188*	Trowel & Square	3/8"	8-3/4"
PL189*	Trowel & Square	1/2"	9-1/2"
PL190*	Trowel & Square	5/8"	10-1/2"
PL191*	Trowel & Square	3/4"	10-1/2"
PL192*	Trowel & Square	1"	10-1/2"
PL193*	Leaf & Square	3/8"	8-1/2"
PL194*	Leaf & Square	1/2"	8-1/2"
PL195*	Leaf & Square	5/8"	9-1/4"
PL196*	Leaf & Square	3/4"	9-1/2"
PL197*	Leaf & Leaf	1/2"	8-1/2"



42" Mag Darby

Reinforced for strength and straightness

Strong, lightweight magnesium is popular with plasterers. Raised ridges on each side for extra strength. Fitted with a 15" rib positioned 5-1/2" from the end and a knob handle centered 7-1/2" from the edge.

Packed 3 per carton

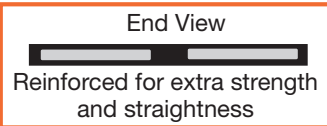

No.	Size	Edge
PL413	42"	Smooth Edge
PL413D	42"	Double Serrated
PL413S	42"	Single Serrated

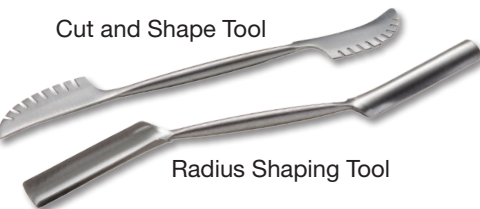

Shaping Tools

Forged and tempered ornamental tools for long life. 9" length.

No.	Description
PL186*	Cut and Shape Tool
PL187*	Radius Shaping Tool



Packed 3 per carton

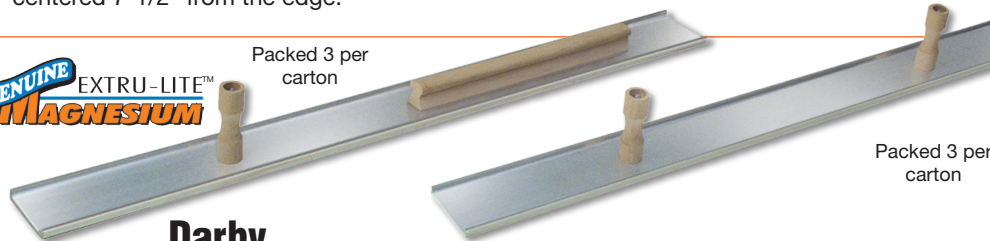

Darby

Strong, lightweight magnesium is popular with plasterers. Raised ridges on each side for extra strength. Fitted with a 15" rib positioned 5-1/2" from the end and a knob handle centered 7-1/2" from the edge.

Smooth Edge

No.	Size
PL400	42"x3-1/2"
PL401	48"x3-1/2"

Double Serrated Edge

No.	Size
PL402	42"x3-1/2"
PL403	48"x3-1/2"

Single Serrated Edge

No.	Size
PL404	42"x3-1/2"
PL405	48"x3-1/2"

Darby With Double Knob Handle

Strong, lightweight magnesium has raised ridges on each side for extra strength. Knobs are centered 11" from each end.

Smooth Edge

No.	Size
PL410	42"x3-1/2"

Double Serrated Edge

No.	Size
PL412	42"x3-1/2"

Single Serrated Edge

No.	Size
PL414	42"x3-1/2"

Packed 3 per carton



Darby with 24" Rib Handle

Strong lightweight magnesium is fitted with 24" long rib handle. Raised ridges on each side for extra strength. Design preferred by many plasterers. 7-1/2" from edge to center of knob and 5-1/2" from end to rib. 48" Darby is 11" from edge to center of knob, 5-1/2" from edge to rib.

Smooth Edge

No.	Size
PL400-24	42"x3-1/2"
PL401-24	48"x3-1/2"

Double Serrated Edge

No.	Size
PL402-24	42"x3-1/2"
PL403-24	48"x3-1/2"

Single Serrated Edge

No.	Size
PL404-24	42"x3-1/2"
PL405-24	48"x3-1/2"

*See page 178

CORNER TOOLS



Stainless Steel Outside Corner Trowels - 90°

Great for detailing outside corners for EIFS, stucco and plaster. Leaves a clean, smooth corner. Trowels have 90 degree angle.

No.	Size	No.	Size
PL590PF	3-1/8"x1/2"	PL593PF	4"x1-1/2"
PL591PF	3-1/8"x3/4"	PL594PF	4"x2"
PL592PF	3-1/8"x1"		



Stainless Steel Inside Corner Trowels - 90°

Great for detailing inside corners for EIFS, stucco and plaster. Leaves a clean, smooth corner. Trowels have 90 degree angle.

No.	Size	No.	Size
PL580PF	3-1/8"x1/2"	PL583PF	4"x1-1/2"
PL581PF	3-1/8"x3/4"	PL584PF	4"x2"
PL582PF	3-1/8"x1"		



EIFS Corner Tools

Stainless steel blade with rust-resistant tang and hardwood handle. Ideal tool for finishing corners, grooves, inset/offset trim lines, around doors and windows.

No.	Size	Corner
PL504	3"x1"	Outside
PL505	3"x1"	Inside
PL506	3"x1-1/2"	Outside
PL507	3"x1-1/2"	Inside
PL508	3"x2"	Outside
PL509	3"x2"	Inside

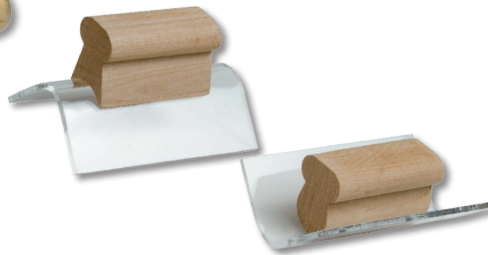

Plastic Corner Tools

Durable 4" plastic blade with 1-1/2" sidewalls to create inside and outside corners. Great tool for pool, plaster, or stucco jobs. No worry of carbon marks on light colored material. Choice of 1/2" or 3/4" radius.

No.	Radius	Corner
PL010	1/2"	Inside
PL012	1/2"	Outside
PL014	3/4"	Inside
PL016	3/4"	Outside

Thin Coat Angle Trowel

Made of flexible stainless steel. Has 90° angle. 4" wide blades are tapered back from 5" at center to 4-1/4" at outside edge.

No.	Handle
PL320	Wood
PL320PF	ProForm®

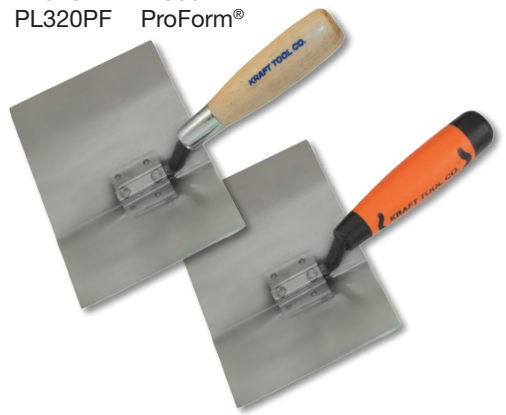

Stainless Steel Corner Tools

The 4" stainless steel blade with 2" sidewalls to provide proper coverage of the corner. Complete with smooth wood handle.

A) Outside Nose Tool

No.	Radius
PL011	1/8"
PL013	1/4"
PL015	3/8"
PL017	1/2"
PL021	3/4"
PL019	90°



A
Outside

B) Inside Cove Tool

No.	Radius
PL011IS	1/8"
PL013IS	1/4"
PL015IS	3/8"
PL017IS	1/2"
PL021IS	3/4"
PL019IS	90°



B
Inside



Miter Rod

Knife edge is ideal for cutting cornices on plaster walls. Durable steel construction. All rods are 4" wide.

No.	Size	No.	Size
PL106	6"	PL116	14"
PL108	8"	PL120	20"
PL110	10"	PL124	24"
PL112	12"		



Flat Wire Texture Broom

Produces a uniform groove surface. Tine row is 11-1/8" long. Flatwire tines measure 3-5/8" in length on 1/2" spacing. Perfect for small jobs.

No.	Size
CC201	12"

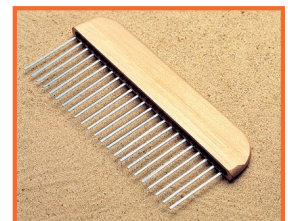



EIFS Notch Trowels

Stainless Steel Notched Trowels

12"x5" Stainless steel notched trowels allow accurate application of EIFS materials. Choice of handles.

Wood No.	ProForm® No.	U Notch Size
PL623	PL623PF	1/4"x1/4"x1-1/2"
PL624	PL624PF	3/8"x1/2"x1-1/2"
PL625	PF625PF	1/2"x1/2"x2"
PL626	PL626PF	3/16"x3/8"x1-7/8"

EIFS TOOLS

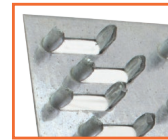

Tooth Detail



EIFS Plastic Trowel

Smooth non-marking ABS blade with comfortable handle grip. Ideal for specialty coating and materials.

No.	Size
PL799*	11"x5"

Sharp Tooth Rasp

Heavy-duty rasp prepares surfaces for plaster and stucco applications. Zinc plated blade has 8mm teeth protruding to scrape through the hardest polymer renders. Creates a more decorative finish by exposing aggregate before final finish. Use the same day as the final set.

No.	Size
PL522	9-7/8"x5-3/4" (250.9mm x 146.1mm)



Exterior Finishing Trowel

Used for applying exterior coatings. Lightweight and durable plastic blade. Comfortable molded plastic handle.

No.	Size
PL801*	11"x5-1/2"



Hi-Craft® EIFS Float

Use for a textured finish on EIFS material and stucco. White blade won't discolor materials. Durable break-resistant lightweight plastic. Rounded corners and edges won't gouge. Must order cartons of 6.

No.	Size
HC797*	12"x5"

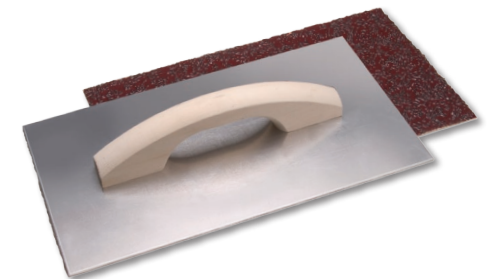
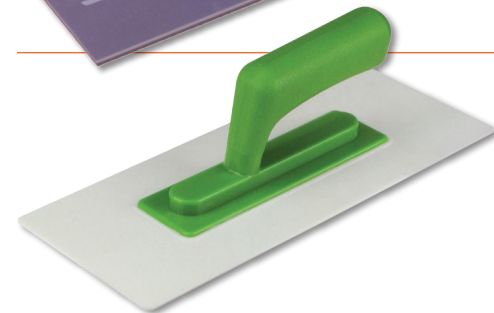

EIFS Sanding Rasps

These giant sanding rasps have very coarse #12 grit sandpaper faces for use on EIFS wall finish systems. Sandpaper glued to face of aluminum back. Comes with wood float handle for comfortable grip.

No.	Size
PL516	14"x2" Rasp
PL515	14"x4" Rasp
PL520	14"x6" Rasp
PL514	14"x8" Rasp
PL519	14"x2" Repl. Self-Adhesive Sheet
PL518	14"x4" Repl. Self-Adhesive Sheet
PL521	14"x6" Repl. Self-Adhesive Sheet
PL517	14"x8" Repl. Self-Adhesive Sheet

PL379 Contact Cement (One Pint) for Sandpaper Replacement

Elite Series™ EIFS RASPS



Blade Detail

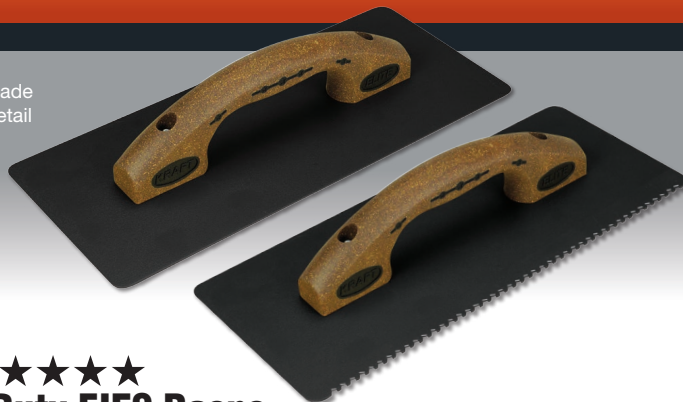

Elite Series™ ★★★★★ Five Star Heavy-Duty EIFS Rasps

Quality construction is used in the long lasting tool. Prep the surface with heavy grit blade and shear down high spots for maximum adhesion. Choose the notched rasp, to use the claw shaped notches to get into hard-to-reach places, such as corners. This top-of-the-line tool is complete with a cork handle providing ultimate comfort and firm grip.

Straight Edge		Notched Edge	
No.	Size	No.	Size
PLE640K	14"x4"	PLE641K	14"x4"
PLE642K	14"x6"	PLE643K	14"x6"

View More Elite Series™ Tools

Finishing Trowels	Pages 4-6
Hand Floats	Pages 16-17
Edgers, Groovers, Step Tools	Pages 52-54

*See page 178 Elite Series™ Five Star Cork Hand Float Handle (Patent Pending)

Jiffler Mixers

- Unique wheel design evenly mixes drywall mud, pigment and other materials
- Dispersal wheels engineered to evenly mix materials and eliminate lumps
- Zinc-plated steel wheels will stand up to a long life of use
- Adjustable wheels adapt to many different containers and materials
- Flat sides on shaft prevent slipping in drill chuck on large size mixers
- Removable wheels make clean up easy

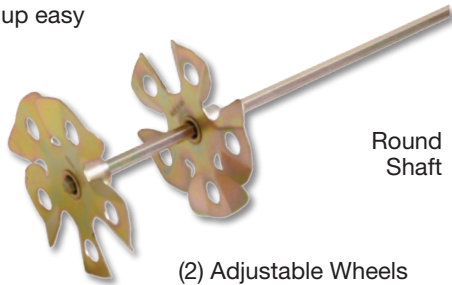

Round Shaft

(2) Adjustable Wheels with 3-Sided Non-Slip Chuck Shaft

2 Wheels

2-1/2" Wheels attach to a 1/4"x11" shaft. Great for small containers and thinner materials such as paint and powdered materials. Use with a 1/4" drill or larger.

No. DC342

3-1/2" Wheels adjust along the 3/8"x16" shaft. Use a minimum 1000 plus rpm power depending on the container and viscosity of material. Use with 1/4" drill or larger.

No. DC343

5" Wheels attach to the 3/8"x24" shaft. Easily mixes drywall mud, thinset mortar, grout and other powdered materials. Use with a 1/2" drill mixer at 450 rpm.

No. DC310

6-1/2" Wheels adjusts along the 1/2"x24" shaft to mix larger containers of material. Blend a two-sack batch in one minute. Perfect for use with a 12" to 16" diameter container. Use with 1/2" drill mixer.

No. DC312



Round Shaft

(3) Adjustable Wheels with 3-Sided Non-Slip Chuck Shaft

3 Wheels

Design thoroughly mixes components for smoothness. Mix 5 gallons of drywall mud in less than 2 minutes with this mixer. Three 5" mixing wheels can be adjusted on the 3/8"x24" shaft. Use with a 1/2" drill mixer.

No. DC311

DRYWALL MUD MIXERS

Junior Mud Mixer

Ideal for mixing drywall mud and texture materials. Rounded end design for better balance when mixing. Mud mixer has a cast aluminum paddle 8-1/2"x5" deep. 7/16" steel shaft works in slow speed 1/2" drill.

No.	Shaft Size
DC713	7/16" Diam. x 30" Shaft
DC714	7/16" Diam. x 36" Shaft
DC714L	7/16" Diam. x 46" Shaft

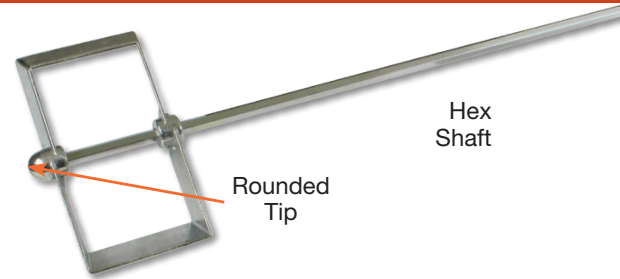

Hex Shaft

Rounded Tip

Fast-Mixers

Heavy-duty mixer is ideal for mixing drywall mud, acoustic or blending paint. Mixer has an aluminum paddle 9"x4" deep. 7/16" diam. steel shaft fits any 1/2" or larger slow-speed drill.

No.	Shaft Size
DC307	7/16" Diam. x 28" Length
DC308	7/16" Diam. x 36" Length



Hex Shaft

Spiffy Mixers

Ideal for small pigment mixes and other materials. Double or triple 5" diam. fan blade mixer, zinc-plated adjustable or welded blades. Non-slip 3/8" steel hexagon shaft for durability. Fits 1/2" slow speed drill.

No.	Wheels	Shaft
DC302	2	24" Adjustable
DC303	3	24" Adjustable
DC304	2	24" Welded (Fixed)
DC305	3	24" Welded (Fixed)

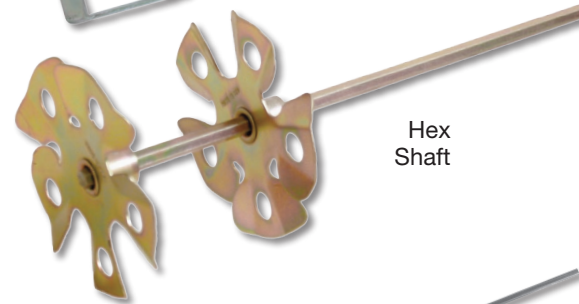

Hex Shaft

Unomixers

Ideal for fast mixing of all kinds of materials, from paint to cement. For use in a 1/2" drill.

No.	Shaft Size
DC362*	2-1/2" Diam. x 16" Length
DC363*	3-1/4" Diam. x 16" Length
DC365*	4-3/4" Diam. x 30" Length
DC367*	5-1/2" Diam. x 30" Length



Hex Shaft

Deluxe Mud Mixer

Mixes all kinds of drywall mud and texture materials fast and completely. Works in 5 to 55 gallon drums. Mixer works in slow speed 1/2" or larger drill. Paddle works in 9-3/8" wide, and 6-1/4" deep, with 2" wide center.

No.	Shaft Size
DC715	7/16" Diam. x 30" Length

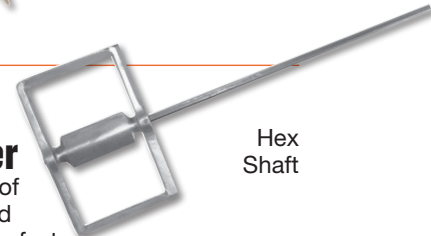

Hex Shaft

Egg Beater Mixer

Use to mix thinset, grout and concrete products. Plated solid steel. Easy to use, easy to clean. 7/16" steel hex shaft. 30" overall length. For use in a 1/2" drill or larger.

No. DC716*

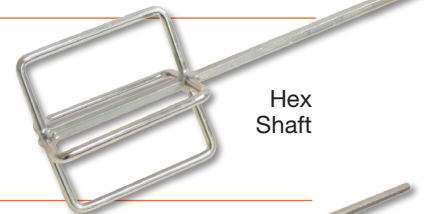

Hex Shaft

Stainless Steel Jiffy Mud and Paint Mixers

For heavy-duty jobs. Fits 5-10 gallon containers. 20-1/2" long, 1/2" shaft, top diameter 4-5/8", bottom diameter 5", depth 5". Use with 1/2" drill.

No. DC409

For small containers 2 gallons or less. 10-1/4" long, 1/4" shaft, top diameter 2-5/8", bottom diameter 2-5/8", depth 2-3/8". Use with 3/8" drill at 450-750 RPMs for best results. **No.** DC408

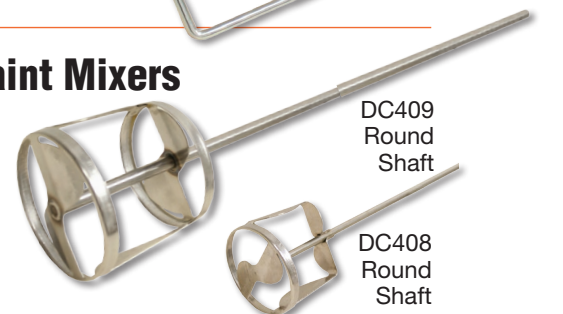

DC409 Round Shaft

DC408 Round Shaft

GUNS, HOPPERS & TEXTURE COMPRESSORS



Compressor Unit

Ideal for: Walls and Ceilings, Fire Proofing, Stucco, Decking, Waterproofing

- Unit is equipped with a 1.0 H.P. capacitor-start electric motor with manual re-set thermal overload protector
- Rotary vane compressor
- Two-wheel cart is 19" wide, 34" high and measures 15" front to back
- Heavy-Duty 200 P.S.I. hose, resists kinking
- The 8"x1.75" wheel and tire have a load rating of 100 lbs. each. Shipping weight is 103 lbs.

DO NOT USE SYNTHETIC OIL
Manuals and replacement parts available on www.KraftTool.com

PC401

EZY Deck Pro Gun and Hopper

Sprays overlay and decking material

- Built-in 40° downward hopper angle ideal for decks and floors with flexible neck
- Control the 2.5 gallon hopper with built-in finger tip handle
- Full grip trigger for ease and comfort
- Remove nozzle and tip for quick and easy cleaning

- PC406 Gun ONLY
- PC407 Nozzle Repair Kit
- PC409 Flexible Neck ONLY



Flexible neck for various positions

PC400

EZY Deck Pro Gun and Hopper with Compressor (Complete Unit)



PC201

ProForm® Texture Gun and Hopper

Sprays a variety of textures and materials

- Large 2.5 gal hopper with built in control handle, 40 degree hopper angle for easy spraying
- Hopper angle easily lets user direct spray for walls and ceilings
- Full grip trigger for ease and comfort
- Remove nozzle and tip for quick and easy cleaning

- PC406 Gun ONLY
- PC407 Nozzle Repair Kit



PC200

ProForm® Texture Gun and Hopper with Compressor (Complete Unit)



PC501

Standard Texture Gun and Hopper

Ideal for spraying walls, ceilings, fireproofing and stucco

- Texture gun made of cast aluminum for long wear
- 1.75 gallon hopper is angled for walls and ceilings
- Top hopper handle for easy control of hopper
- Sprays a variety of textures

- PC506 Gun ONLY
- PC507 Repair Kit for Standard Gun



PC500

Standard Texture Gun and Hopper with Compressor (Complete Unit)



PC301

Super-Pro® Texture Gun and Hopper

Sprays a variety of textures and materials

- Large 2.5 gal hopper with built in control handle, 40 degree hopper angle for easy spraying
- Easy pull full grip bronze trigger for less fatigue
- Special orifice adjusting nut makes orifice selection quick and easy
- Patented Super-Pro® gun cylinder and shut off valve

- PC306 Gun and Super-Pro® Cylinder
- PC307 Super-Pro® Gun Cylinder ONLY



PC300

Super-Pro® Texture Gun and Hopper with Compressor (Complete Unit)



DRYWALL KNIVES



Standard Taping Knives

Blue Steel or Stainless Steel

Each taping knife has a lightweight aluminum mounting. The tapered blade is balanced and flexible for just the right feel. Features a secure ProForm® soft grip handle. Choose a blue steel blade for additional flexibility.

<u>Blue Steel</u>	<u>Stainless Steel</u>	
No.	No.	Size
DW808PF	DW808PFSS	8"x3"
DW810PF	DW810PFSS	10"x3"
DW812PF	DW812PFSS	12"x3"

Bucket Scoop

Scoops drywall mud, stucco, and other similar material. Stainless steel blade with non-slip ProForm® handle. Curved radius blade is sized to fit bucket sides for easy removal of material.

No. DC421



Deluxe Taping Knives

Blue Steel or Stainless Steel

Wide flexible blue spring steel or stainless steel blade in lightweight rustproof aluminum mounting. Features soft grip ProForm® handle.

<u>Blue Steel</u>	<u>Stainless Steel</u>	
No.	No.	Blade Size
DW906PF	DW906PFSS	6"x3"
DW908PF	DW908PFSS	8"x3"
DW910PF	DW910PFSS	10"x3"
DW912PF	DW912PFSS	12"x3"
DW914PF	DW914PFSS	14"x3"

Deluxe Short Taping Knives

Stainless Steel

1-3/4" stainless steel blades is stiffer for finishing control.

No.	Blade Size
DW635PFSS	12"x1-3/4"
DW636PFSS	16"x1-3/4"
DW637PFSS	20"x1-3/4"

Long Handle Taping Knives

The 16" long wood handle makes these knives popular on the job. Blade is made of flexible blue spring steel.

No.	Size
DW628	18"x4"
DW630	20"x4"
DW634	24"x4"



Long Handle Broad Knives

A) Choice of 7" or 9" wide blue spring steel blade with rounded corners attached to an aluminum handle. Overall length 18-1/2". Reinforced where the blade attaches to handle. Easy to change replaceable blade.

No.	Size
DW281	7" Broad Knife
DW281-01	7" Replacement Blade
DW277	7" Broad Knife with 28" Handle
DW282	9" Broad Knife
DW282-01	9" Replacement Blade

B) 6' aluminum button handle (CC336) attached to broad knife for extra long reach.

No.	Size
DW283	9" Broad Knife with 6' Button Handle

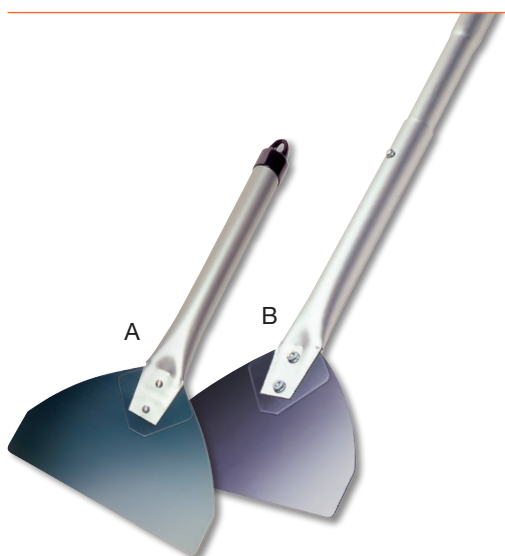

Rugged plastic handle, with hammer end



Professional Hammer End Joint/Taping Knives

Flexible carbon steel blade is ground and polished for a professional finish. Comfortable handle with convenient hammer end for nail setting.

No.	Blade Width
DW527*	1-1/2"
DW528*	2"
DW529*	4"
DW530*	5"
DW533*	6"

Elite Series™ FIVE STAR DRYWALL KNIVES

Elite Series™ Professional Stainless Steel Drywall Knives Single-Piece Construction, Will Not Rust

Non-rust stainless steel blade and handle, one-piece construction for strength and longevity. These knives come in 8 sizes and are ideal for scraping, painting, and drywall applications. Choose from a standard or more flexible limber blade. Comfortable contoured handle is easy to grasp and protects hands from the blade. Also available with a sure grip.

Stainless Steel Handle

No.

DW727*
DW728*
DW706*
DW729*
DW730*
DW733*
DW735*
DW736*

Sure Grip Handle

No.

DW727PF*
DW728PF*
DW706PF*
DW729PF*
DW730PF*
DW733PF*
DW735PF*
DW736PF*

Blade Width

1-1/2"
2"
3" **NEW**
4"
5"
6"
8"
10"

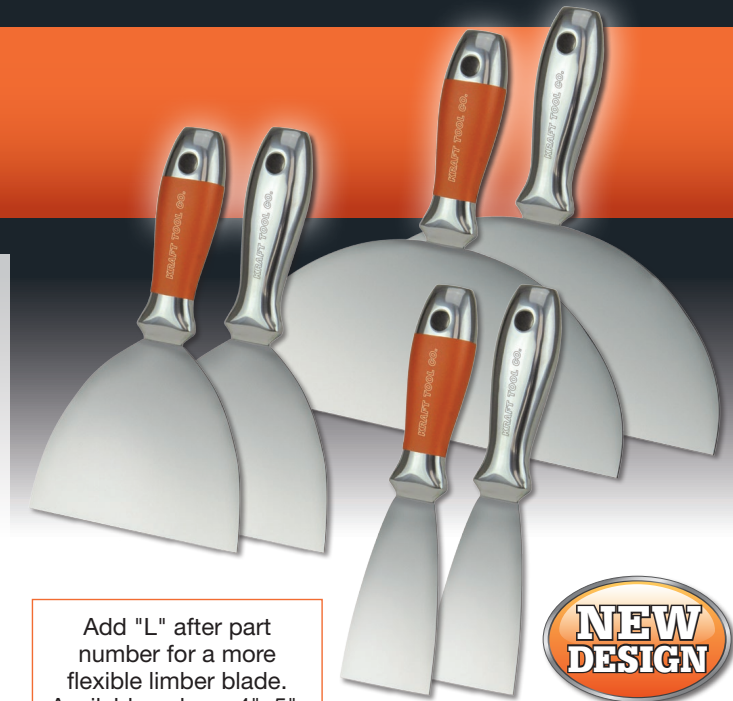

Add "L" after part number for a more flexible limber blade. Available only on 4", 5", 6", 8", and 10" knives.



Elite Series™ Chisel End Stainless Steel Joint Knives

Single bevel edge on a narrow stiff blade for scraping and chiseling.

Stainless Steel Handle

No.

DW704*
DW705*

Sure Grip Handle

No.

DW704PF*
DW705PF*

Blade Width

1-1/2"
3"



Standard WIDE Handle Taping Knife

Blue Steel or Stainless Steel

Strong wide lightweight plastic handle. Fitted with a flexible lightweight blue steel blade. Balanced for effortless taping and finishing.

No.

DW648 8"x3"
DW650 10"x3"
DW652 12"x3"
DW654◊ 14"x3"

Size

Add "SS" to part no. for Stainless Steel

NEW



◊ Available only in Blue Steel

Standard STRONG Handle Taping Knife

Blue Steel or Stainless Steel

Reinforced high strength yellow plastic handle. Fitted with a flexible lightweight blue steel blade. Well balanced and easy to use.

No.

DW008 8"x3"
DW010 10"x3"
DW012 12"x3"

Size

Add "SS" to part no. for Stainless Steel



Add "SS" to part no. for Stainless Steel

Drywall Trowels

This trowel comes with a curved high carbon blade for finishing drywall joints. The blade is broken in and ready for use. A lightweight, flexible tool with perfect balance.

Wood

No.

DW521
DW541
DW516

ProForm®

No.

DW521PF
DW541PF
DW516PF

Size

12"x4-1/2"
14"x4-1/2"
16"x4-1/2"



Flexible Wipe Down Knife

Flexible rubber knife for taping and cleaning excess mud from inside angles. Ideal for splay and angles that are wider than 90 degrees. Lightweight and easy to clean. Can be used by hand or with any 1" diameter pole. No. DW438

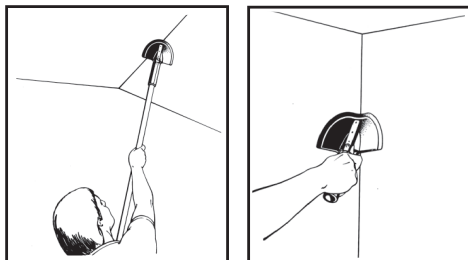

Round It Tool

Flexes for just the right angle!

With just a push of the thumb you can adjust the angles of this tool as you go. For smooth professional outside angles and round corners. Overall length 10-1/4". No. DW454



Adjustable Wipe Down Knife

Two knives in one. A flexible rubber taping and wipe down knife for inside 90 degree angles. Then loosen the wing nut, and turn the pad around for angles over 90 degrees. No. DW453



Just loosen nut and rotate for less than 90 degrees or...over 90 degree angles

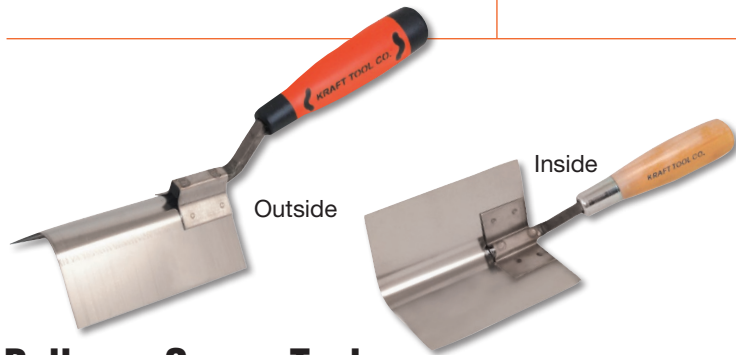

Bullnose Corner Tool

Bullnose corner tools create corners with a rounded edge for a decorative look. Blade angles flex to 90 degrees when used. Lightweight stainless steel blade is 5" long with 2-1/2" sidewalls.

<u>Wood Handle</u>	<u>ProForm® Handle</u>	Description
No.	No.	
DW451	DW451PF	Outside
DW450	DW450PF	Inside



Inside Corner Tool

The 5" long flexible stainless steel blade with 4" sidewalls. Its 103 degree angle flexes to 90 degrees for perfect corners. This is a lightweight, perfectly balanced tool.

No.	Handle
DW520	Wood
DW520PF	ProForm®

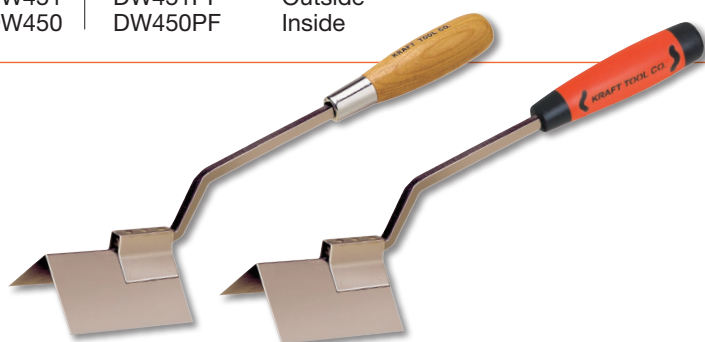

Outside Corner Tool

Long Handle

Flexible 3" stainless steel blade with 2" sidewalls. Will not rust or pit. Great for finishing around windows and hard-to-reach areas. Overall length 13".

No.	Handle
DW519	Wood
DW519PF	ProForm®



Outside Corner Tool

Made of stainless steel. Will not rust or pit. 80 degree angle flexes to 90 degrees when used. 5" long at center and tapers to 4-1/4" at outside edge.

<u>Wood Handle</u>	<u>ProForm® Handle</u>	Blade Depth
No.	No.	
DW619	DW619PF	2-1/2"
DW621	DW621PF	4"



Heli-Arc Stainless Steel

These heli-arc welded mud pans have tapered ends and sides. Pan resists rust and is easy to clean. Sides are sheared to clean knife easily. Measures 3-1/4" deep.

No.	Size
DW710	10"
DW712	12"
DW714	14"
DW718	18"

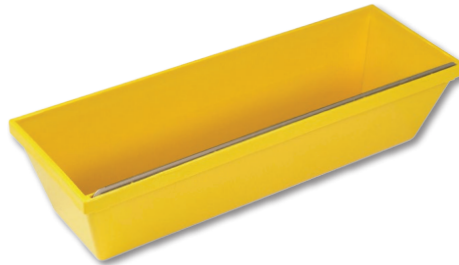

Plastic Mud Pan

These heavy-duty plastic mud pans have tapered ends and sides with one replaceable steel wiping blade. Resists chemicals, and will not break if dropped.

No.	Size
DW210	10"
DW212	12"
DW214	14"

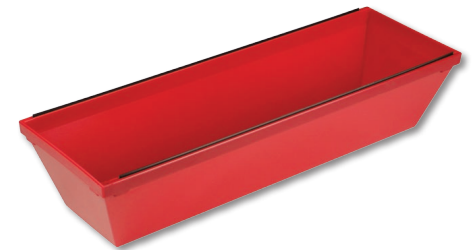

Plastic Double Bladed Mud Pan

12" double bladed plastic is more pliable than our standard mud pan. Designed so you can wipe your knife clean on both sides. Measures 3-1/4" deep.

No.	Size
DW312	12"

EZ-GRIP Mud Pans Unique Non-Slip Textured Surface

Heli-arc welded stainless steel mud pans feature a non-slip textured surface which provides the professional finisher with a more secure grip and less hand fatigue.



Stainless Steel EZ-Grip Mud Pan

Mud pans have tapered ends and sides. Sides are sheared to clean knife easily. Pan resists rust and is easy to clean.

No.	Size
DW720	10"
DW722	12"
DW724	14"

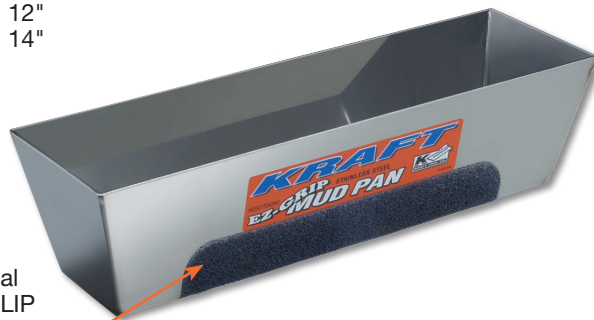

Special
NON-SLIP
textured surface

Round Bottom EZ-Grip Mud Pan

Smooth tapered ends with contoured corners. Sides sheared to clean knife easily. Natural contour for comfortable, non-slip grip.

No.	Size
DW723	10"
DW725	12"
DW726	14"

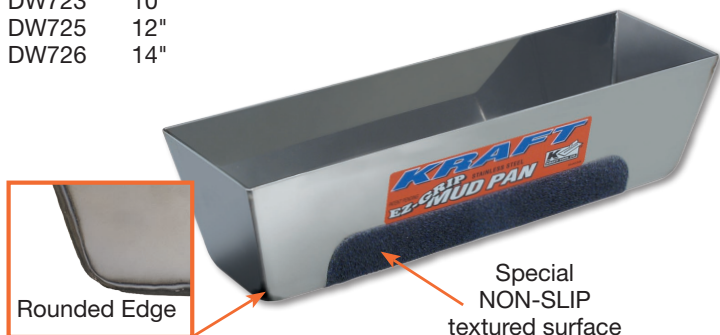

Rounded Edge

Special
NON-SLIP
textured surface



Mud Pan
not included

Mud Pan Cover

Cover your mud pan when not in use, to help prevent drywall mud from drying out. Fits most metal mud pans 12"-14" long.

No.	Size
DW708	12"
DW709	14"

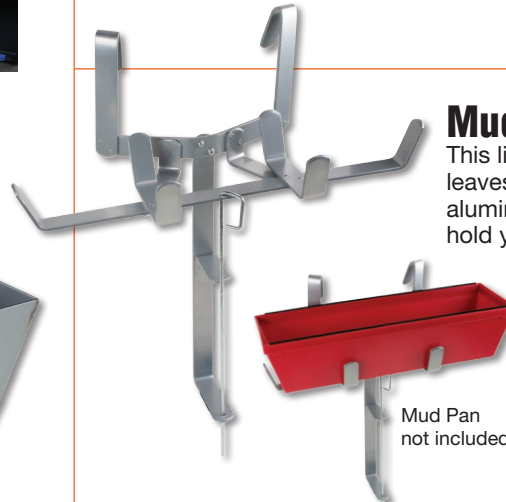

Mud Pan
not included

Mud Pan Holder

This lightweight mud pan holder leaves your hands free to work. All aluminum, hooks to your belt to hold your mud pan where you can easily get at it. Holds 12"-14" mud pans. Designed with a hook below the pan to hold a roll of tape.

No. DW207

Drywall Mud Holder

Stainless steel mud holder is designed for plaster or drywall work. Zinc-plated screws securely fastens the comfortable wooden handle to blade. Includes sponge rubber callous preventer.

No.	Size	Lip
DW460	12"x6"	1-1/2"



Mud Masher

Quickly and easily mix small batches of mud. Heavy steel wire forms the 5"x5-1/2" head, perfect for moving through and mixing the material. Durable wood handle is secured to head. Overall length makes it easy to use in buckets.

No.	Overall Length
DW103*	24-1/4"
DW103L*	36"



*See page 178



Corner Roller

Apply joint compound or drywall mud. Sturdy handle for easy reach. Comes with replaceable lambs wool cover and plastic handle with threaded end for extended reach.

No.	Description
DC267	3" with 14" Handle Corner Roller
DC268	3" Lamb's Wool Cover Replacement



Clinch-On Tool

Clinch-On tool is operated by a spring loaded arm. A sharp blow from a rubber mallet (sold separately) drives the cornerbead on tight, centers it and clinches it in position without nails or screws.

No.	Size
DC806*	1-1/8" Bead (less Mallet)
DC807*	1-1/4" Bead (less Mallet)
DC808*	Repair Kit (fits both sizes)
DC809*	Black Rubber Mallet 28 oz.
FC551*	White Rubber Mallet 30 oz.
DC810*	Kit of 1-1/4" Bead Clinch-On Tool Plus Black Rubber Mallet 28 oz.

Crows Foot Texture Brush

Texture brush made with white tampico fiber, set in a 1-3/4"x6-3/8" hardwood block. Threaded handle hole in center (handles sold separately, see page 86). Single brush measures 8-1/2" wide, 13-1/2" long when flattened.

No.	Description
DW118	Single Brush
DW118D	Double Brush



Stud Crimping Tool

A specially designed tool for setting light gauge metal studs and track, furr downs, door and window headers. Use on .25 gauge or lighter galvanized metal. Secures metal to metal. Weighs only 14 oz.; 10" long.

No.	Description
GG163	Stud Crimping Tool
GG163-01	1/4" Replacement Crimper
GG163-02	1/4" Replacement Bushing



1/8" Rivet Hole Punch

Designed specifically for acoustical grid systems. Cuts perfect 1/8" holes for painted or aluminum rivets. Reduces installation time up to 30%. High strength alloy weighs only 14 oz.; 10" long.

No.	Description
GG159	Rivet Hole Punch
GG159-01	1/8" Replacement Punch
GG159-02	1/8" Replacement Bushing



Flexible Putty Knives

Industrial quality stainless steel flexible blades. Wood handles with brass rivets.

No.	Size
A) DW002	2"

Combination Tool

Five heavy-duty tools in one: scraper, seam opener, spreader, putty remover, and cutout removes paint from rollers. Wood handle with brass rivets.

No.	Size
B) DW027	2-1/4"

Heavy "Chisel" Scraper

Thick (.058) stainless steel, single bevel blade with brass riveted wood handle.

No.	Size
C) DW025	1-1/2"

Stiff Scrapers

Wood handle with brass rivets, 3" wide stainless steel stiff blade scraper of the best quality. Single bevel on all models.

No.	Description
D) DW033	Standard
E) DW034	Long Handle
F) DW035	Bent Blade

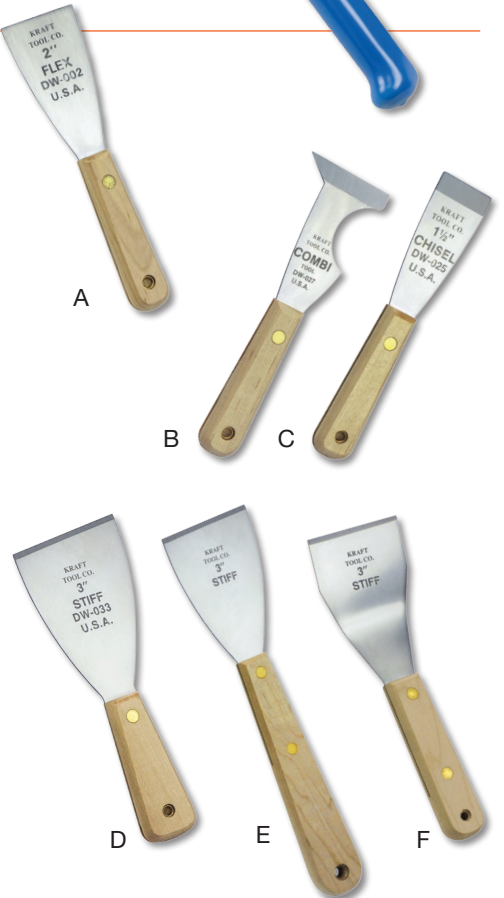

Drywall Texture Brush

The perfect brush for texturing. Use it in your hand or with a threaded handle (sold separately, see page 86). This brush is made of horsehair and fiber bristles and are available in 2 sizes.

No.	Bristles	Diam.
DW116	2-1/2" Long	6"
DW117	3-1/2" Long	9"



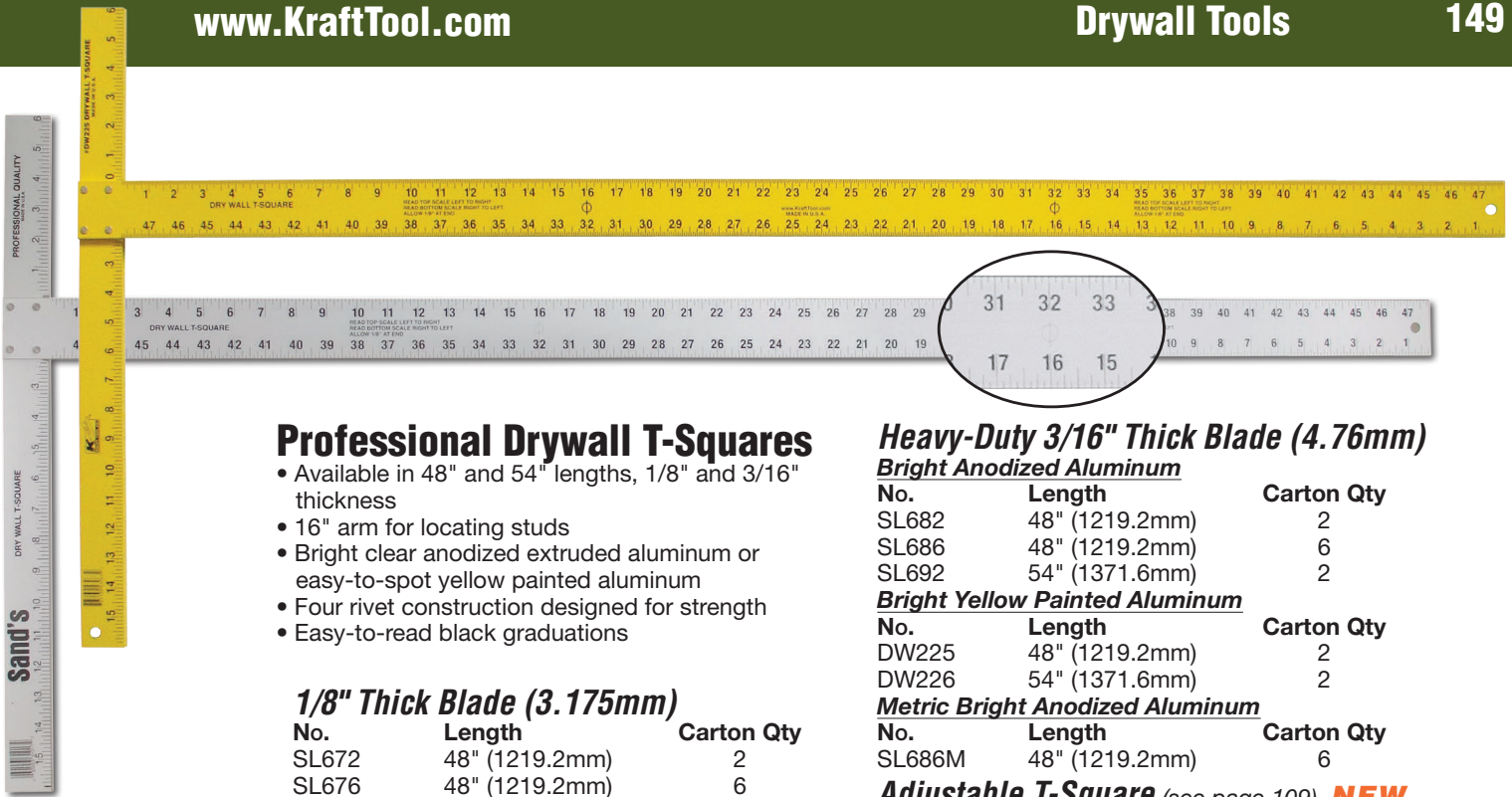

Professional Drywall T-Squares

- Available in 48" and 54" lengths, 1/8" and 3/16" thickness
- 16" arm for locating studs
- Bright clear anodized extruded aluminum or easy-to-spot yellow painted aluminum
- Four rivet construction designed for strength
- Easy-to-read black graduations

1/8" Thick Blade (3.175mm)

No.	Length	Carton Qty
SL672	48" (1219.2mm)	2
SL676	48" (1219.2mm)	6

Heavy-Duty 3/16" Thick Blade (4.76mm)

Bright Anodized Aluminum

No.	Length	Carton Qty
SL682	48" (1219.2mm)	2
SL686	48" (1219.2mm)	6
SL692	54" (1371.6mm)	2

Bright Yellow Painted Aluminum

No.	Length	Carton Qty
DW225	48" (1219.2mm)	2
DW226	54" (1371.6mm)	2

Metric Bright Anodized Aluminum

No.	Length	Carton Qty
SL686M	48" (1219.2mm)	6

Adjustable T-Square (see page 109) **NEW**

No.	Length	Carton Qty
SL680*	48" (1219.2mm)	4



Soffit Square

Polished steel used in metal stud framing to square soffit track and studs. Special 2" wide notch in square fits over stud track to allow correct alignment with no track / lip interference. Easy-to-read 1/8" and 1/4" graduations.

No.	Description
DW242	12"x8"



Professional Drywall Square with Lip

- Bright, clear anodized aluminum
- Easy-to-read black numbers and 1/16" graduations
- Perfect for jobs where a smaller tool is needed
- Lip catches board for easy placement and cutting of drywall board or sheet material

No.	Description
SL694	16"x24" with Lip (406.4mm x 609.6mm)

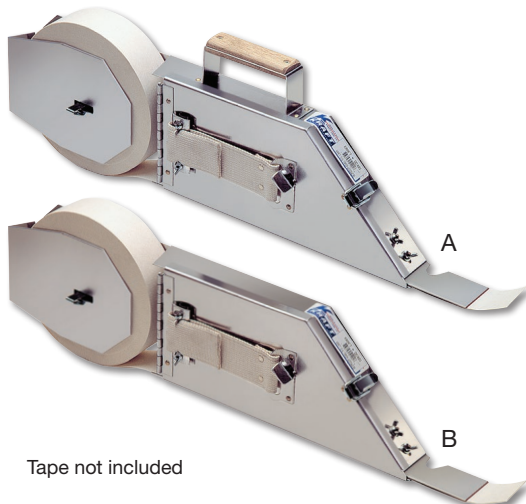
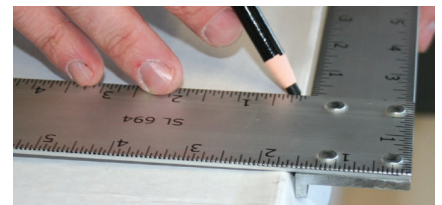

A) Kraft Drywall Taper

Aluminum construction will not rust and is easy to clean up. Stainless steel latch on large capacity mud holder will not rust. Holds all 500' rolls of tape. Adjustable slide/blade moves to regular mud and cuts tape quickly and accurately.

No.	Description
DC401	Right Hand
DC401L	Left Hand

B) K.C. Taper

K.C. taper is made exactly like the Kraft drywall taper, except without the top handle making it more compact. For right hand use.

No. DC402

Tape not included



Drywall Taper

Taper is made of lightweight aluminum with separate mud and tape compartments. Holds up to 500' roll of tape. Easy to adjust mud metering blade. Comes with wood and nylon strap handles. Instructions included.

No. HC540*

*See page 178



Professional Cast Aluminum Drywall Hand Sander

Cast aluminum lightweight base with foam pad and screw clamps keeps sandpaper tight to sander base. High lift wood handle designed for knuckle clearance and balance. Also available with black plastic handle. Sander face is 9-1/2"x3-1/4".

No.	Description
DW441	Wood Handle
DW441P	Plastic Handle (not shown)



Lightweight Drywall Hand Sander

Lightweight aluminum back with foam pad uses clamps to lock the sandpaper tightly to the base. Available with wood or plastic handle. Sander face is 9-1/2"x3-1/4".

No.	Description
DW442	Wood Handle (not shown)
DW442P	Plastic Handle

Drywall Tape Holder

An excellent tool for the drywall finisher. Made of steel for longer life. Holds all standard size drywall tape or metal corner tape. Hangs from belt for easy access. Pull wire for easy refilling.

No. DW224



Dust Mask

Industry accepted N95 disposable respirator mask with foam nose cushion and two elastic straps. Box of 20 masks.

No. GG435*



Drywall Pole Sander

Kraft pole sander makes hard-to-reach places high on walls and ceilings easy to access. Pole sander base is made of lightweight sturdy aluminum; with a bonded 9-3/8"x3-1/4" rubber pad and two positive lock clamps. Swivel head permits sanding anywhere. Includes 48" wood handle.

No.	Description
DC317	Sander with Wood Handle
DC317-01	Sander Head Only
DC318	48" Replacement Wood Handle
DC317ASM	Sander with Wood Handle Assembled (6 pack only)



Extension Handle

Made of lightweight aluminum. Extends from 4'8" to 8' for sanding ceilings and high walls.

No.	Description
DC319	Handle
DC349*	Female/Female Broom Thread Adapter for Pole Sander NEW

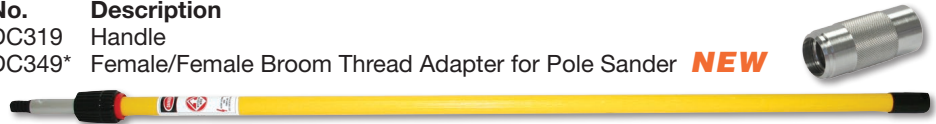

Diecut Sandpaper

Ideal for sanding down drywall joint mud or drywall board. Sheet size 11"x4-3/16".

No.	Grit	Sheets
DC080	80	100
DC100	100	100
DC083	120	100
DC084	150	100

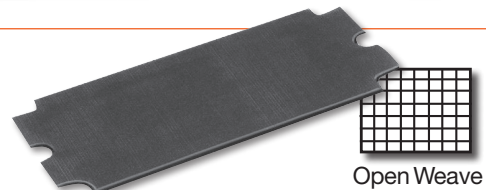

Open Weave

Diecut Fabricut Sandpaper

This open weave silicon carbide sanding cloth practically cleans itself. It lasts longer, and cuts joint mud faster than regular sandpaper and designed to not easily clog. Sheet size 11"x4-1/4".

No.	Grit	Sheets.
DC120	120	50
DC220	220	50

Drywall Patch

The ideal way to repair holes or surface damage. Self-adhesive drywall patch is permanent and made from rustproof aluminum. Easy to cut to any size or shape. Apply over damaged area, cover with a finishing compound, sand and paint...it's that simple.

No.	Size	#of Patches
DC418	4"x4"	50
DC419	6"x6"	50
DC420	8"x8"	25
DC422	12"x12"	10

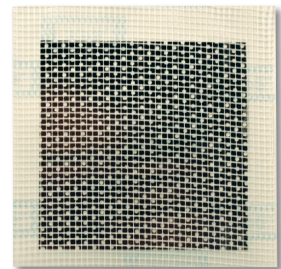

Utility Knife Replacement Blades with Dispensers

Blades come with convenient plastic dispenser. Fits most standard utility knives. Steel blade with 2 notches on top (.025" thickness). 100 Pack has hang holes for easy storage.

No.	Description
DW078*	10 Pack Dispenser (carded)
DW079*	100 Pack Dispenser (carded)



Easy Change Blade Utility Knife

An adjustable blade on a non-slip comfort handle features storage for extra blades. Includes 3 blades.

No. DW040*

Vacuum Sander

Sander attaches to shop type vacs to clean as you sand. Multiple airflow channels minimize dust. Adjustable vent controls vacuum force. Durable plastic construction. Elbow pivots 360° to keep the 6' hose out of the way. Molded rubber base. Knobs on clamps secure sanding screen. Use with Fabricut Screen Sandpaper, sold separately. Sander, 6' hose with coupler, adapter, sandscreen, and instructions included.

No.	Description
HC345*	Vacuum Sander
HC345-01*	6 Ft. Replacement Hose



View more Hi-Craft® Drywall Tools on 93-95

Drywall Hammer

Checked face on 14oz. polished head securely attached to a 16" wood handle for perfect balance.

No. HC535*



DIY Drywall Repair Kit

This 7-piece kit contains the basic tools needed for small to intermediate drywall repairs around the house. Mix material in the hard plastic Mud Pan. Flexible Blue Steel Taping Knife for clean taping. Three sizes of Plastic Joint Knives (2", 4", and 6") allow versatility for small jobs and applying drywall compound. Use the 3-sided Corner Tool for finishing inside or outside corners. Create a smooth finish to your project with the medium grit Sanding Sponge. (See page 94 for individual kit components.)

No. HC100*

Circle Cutter

8-1/2" long calibrated steel shaft enables sharp, clean cuts up to 16" in diameter. Hardened steel cutting blade and center point remain sharp. Chrome plated for long wear. Features English and Metric measurements in 1/4" and millimeters.

No. DW241*

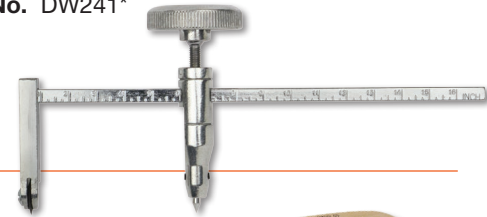

Drywall Hammers



Heavy-Duty

Chrome plated head features a checkered face to make nailing easier and prevents breaking the surface of wallboard. The 1-3/4" blade scores drywall for rough cut openings. The axe blade also has a puller notch for nails. Head is securely attached to a wood handle for perfect balance.

No.	Description
DW254	18 oz. Head / 14" Handle
DW264	18 oz. Head / 16" Handle

Lightweight

Beautifully balanced chrome head has a crowned checkered face to make nailing easy. The lightweight yet durable head is securely attached to a wood handle for a perfect balance.

No.	Description
DW354	13 oz. Head / 14" Handle
DW364	13 oz. Head / 16" Handle

Drywall Saw

Saw blade is hardened and tempered for long wear on drywall. Large teeth designed specifically to cut quickly through wallboard. Wood handle is secured to 15" blade.

No. DW811*



Checked Handle Utility Knife

Checked grip will not slip in your hand. Blade can be adjusted, but does not retract. Storage for extra blades in handle.

No.	Description
DW199	Bulk Packed 48 per Carton (Includes 3 blades each)
DW199C*	with Display Card (Includes 5 blades each)

3-Way Utility Knife

Blade will not slip. Retractable blade can be adjusted to 3 positions. Light but rugged aluminum body. Includes 3 blades.

No.	Description
DW042	Bulk Packed 48 per Carton
DW042C*	with Display Card



DW199



DW042

Economy Drywall Saw

15" blade with specially designed teeth cuts quickly through wallboard. Hardened and tempered blade with soft grip plastic handle.

No. DW814*



Utility Drywall Saw

Rugged construction with sharp point for easy penetration. Aggressive 6" blade is heat treated and securely anchored into a comfortable hardwood handle with steel ferrule to prevent splitting.

No. DW243*

*See page 178