



### Standard Construction Features

Belt Type: Synchronous  
 Core Material: Oil & Heat Resistant (chloroprene)  
 Cord/Tensile: Fiberglass  
 Jacket: Nylon



### Belt Section Dimensions

Tooth Type	Pitch (in)	$h_s$ (in)	$h_t$ (in)
TRAP	1/2	0.155	0.090

### Belt Dimensions

Pitch Length (in)	No. Teeth	Width (in)
32.00 +0.026 -0.026	64	1.500 +0.030 -0.030

### Measuring Information

Y (in)	T (lbf)	No. Teeth	O.D. (in)	Pitch Circum. (in)	Radial Runout (in)	Axial Runout (in)	PLD 2a (in)
11.00 +0.013 +0.013	221	20	3.13	10.00	0.0005	0.0010	0.054

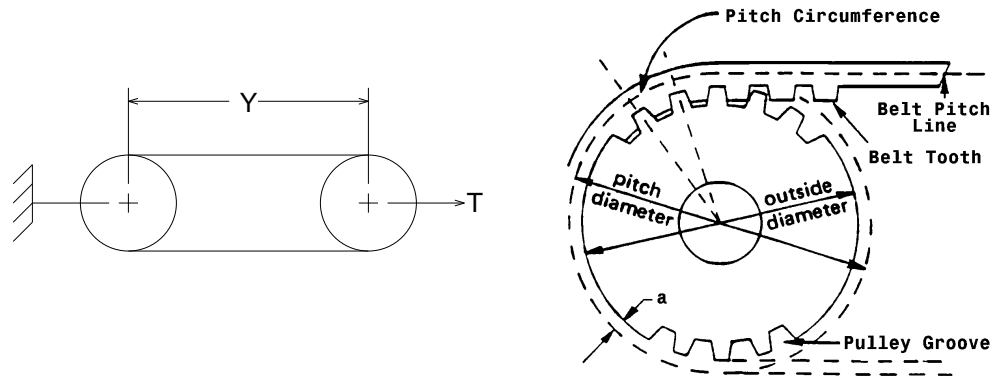

The length shall be measured by placing the belts on two pulleys of equal diameters that have been grooved in accordance with standard specifications and rotated at least three complete turns with the specified tension so that each strand receives half the total tension. The length will be that length obtained by adding the Pitch Circumference of one pulley to twice the center distance (dimension 'Y').



### DesignView™ Belt Information Sheet

Created 28 Jun 2017 by Gates

Created for  
**PowerGrip Timing - H**

Gates Product Number  
**9257-3328**

Customer Part Number  
**320H150**