

**Climax Metal Products Company**

8141 Tyler Boulevard

Mentor, Ohio 44060

USA

Toll free: 800-542-6552

Phone: 440-585-0300

Fax: 800-860-5553

Email: [sales@climaxmetal.com](mailto:sales@climaxmetal.com)Website: [www.climaxmetal.com](http://www.climaxmetal.com)

## ITEM # GSC-131-Z, SET SCREW COLLAR GSC-SERIES

Zinc Plated Steel Set Screw Collar. Traditional cost effective collar design.



[Drawing](#) | [Specifications](#) | [Regulation & Compliance](#)

### Drawing

#### Dimensional Drawing

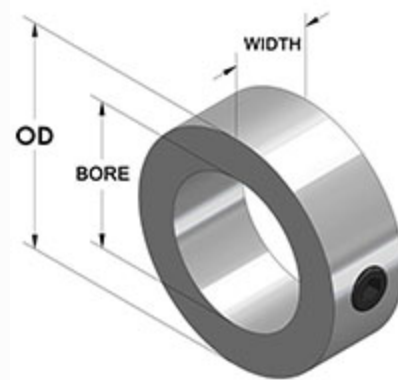

Set Screw Collar

### Specifications

Need Help?

<b>Bore</b>	1 5/16 in
<b>OD</b>	2 1/8 in
<b>Width</b>	11/16 in
<b>Style</b>	Set Screw
<b>Material</b>	Steel, ASTM A108
<b>Finish</b>	Zinc Plated
<b>Set Screw</b>	Hex Socket Set Screw, 3A Thread, Steel, ASTM F912: 3/8-16 x 3/8
<b>Approximate Weight</b>	6.60 oz
<b>UPC Code</b>	044861631317

## Regulation & Compliance

[REACH Compliance Statement](#)

[RoHS 3 Compliance Statement](#)

[Disclosure of Conflict Minerals and Materials](#)

[California Proposition 65 Warning](#)

[Toxic Substances Control Act TSCA](#)

[DFARS Compliance Statement](#)

[Safety Data Sheet](#)

[ISO Certificate](#)