

5/16-24

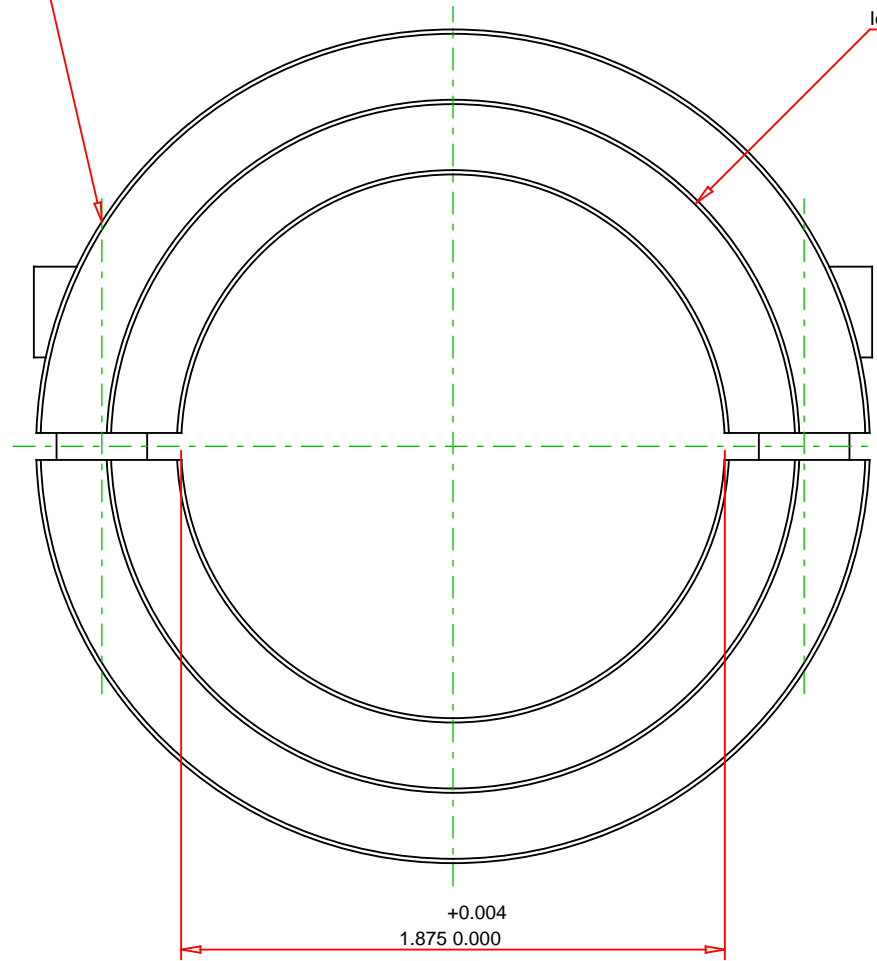

Screw : Hex Socket Cap Screw, 3A Thread, Steel, ASTM A574: 5/16-24 x 1

Note :
- Drawing not to Scale

Part No. :
G2SC-187-B

Material :
Steel, ASTM A108

Finish :
Black Oxide

Description :
Two-Piece, Clamping Collar- G2SC-Series

CLIMAXMETAL
Address : 8141 Tyler Boulevard
Mentor, OH 44060
Phone : 800.542.6552 Fax: 800.860.5553
Email : sales@climaxmetal.com
Web : www.climaxmetal.com